

Vooraanzicht

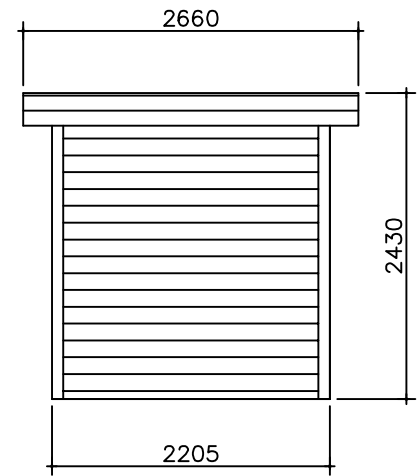

Achteraanzicht

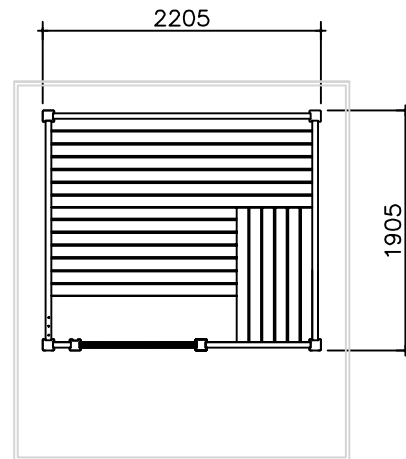

Grondplan

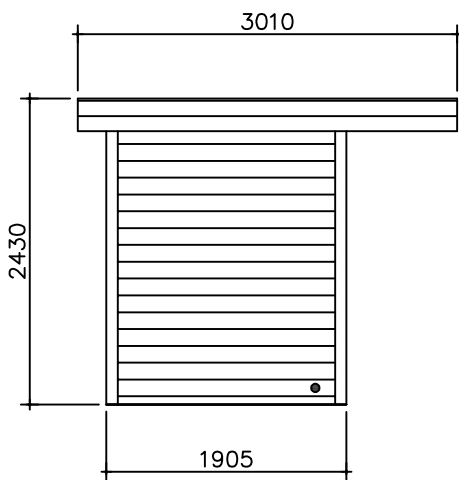

Zijaanzicht links

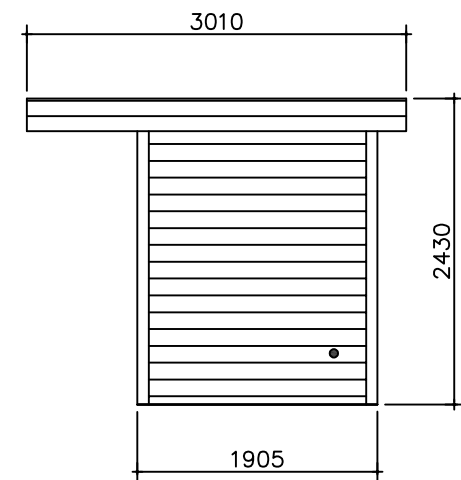

Zijaanzicht rechts

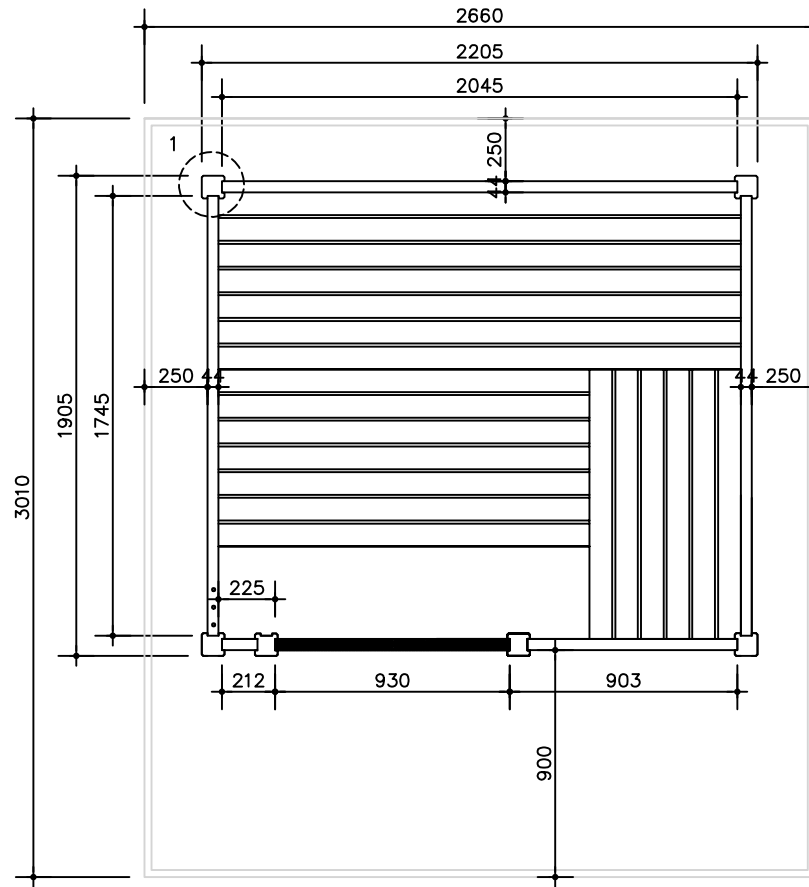

Grondplan

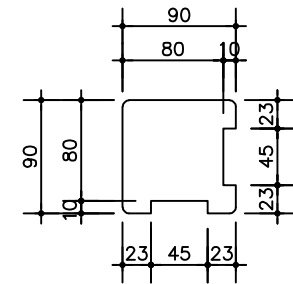

Detail 1

Sauna bio1770 (2205x1905)
 schaal 1:30

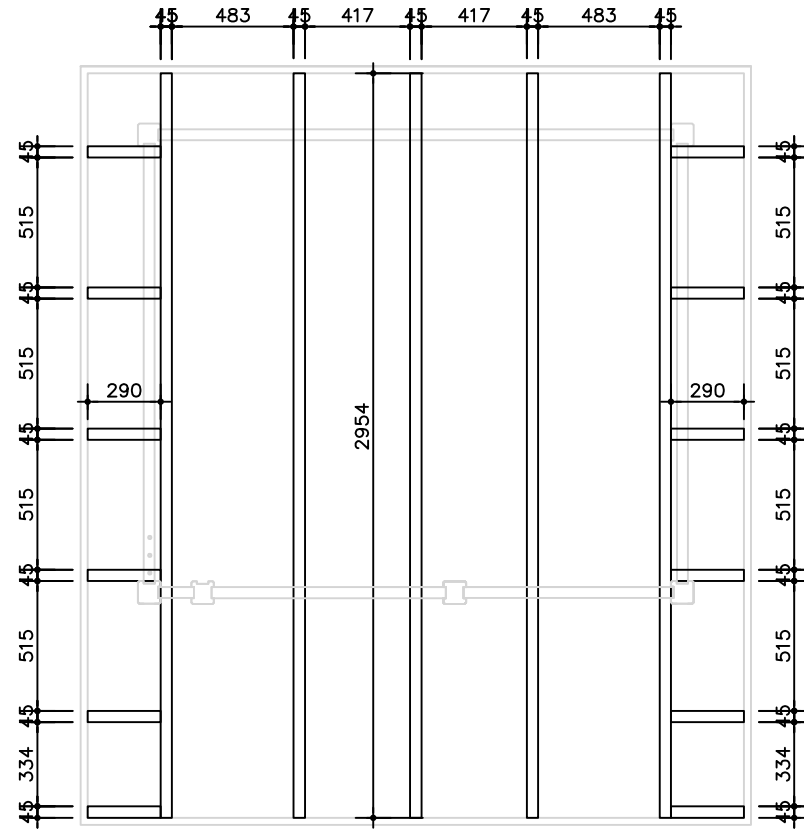

Legplan dakbalken

Sauna bio1770 (2205x1905)

schaal 1:30

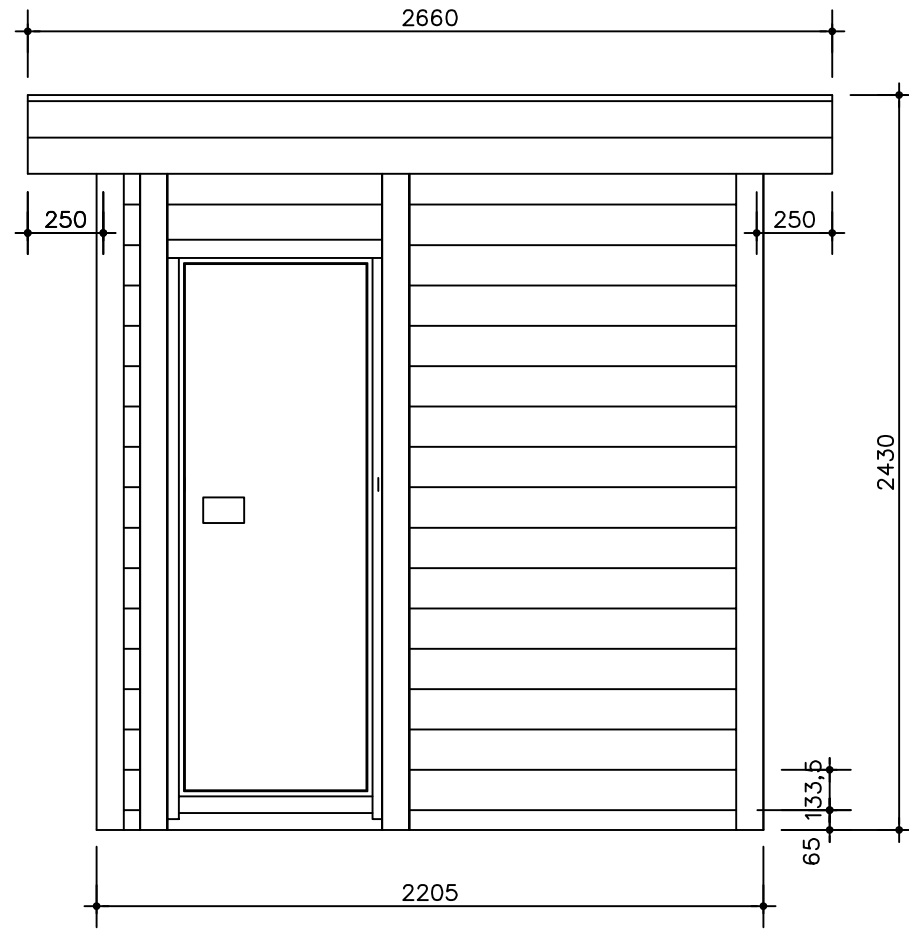

Voorraanzicht

Sauna bio1770 (2205x1905)
schaal 1:25

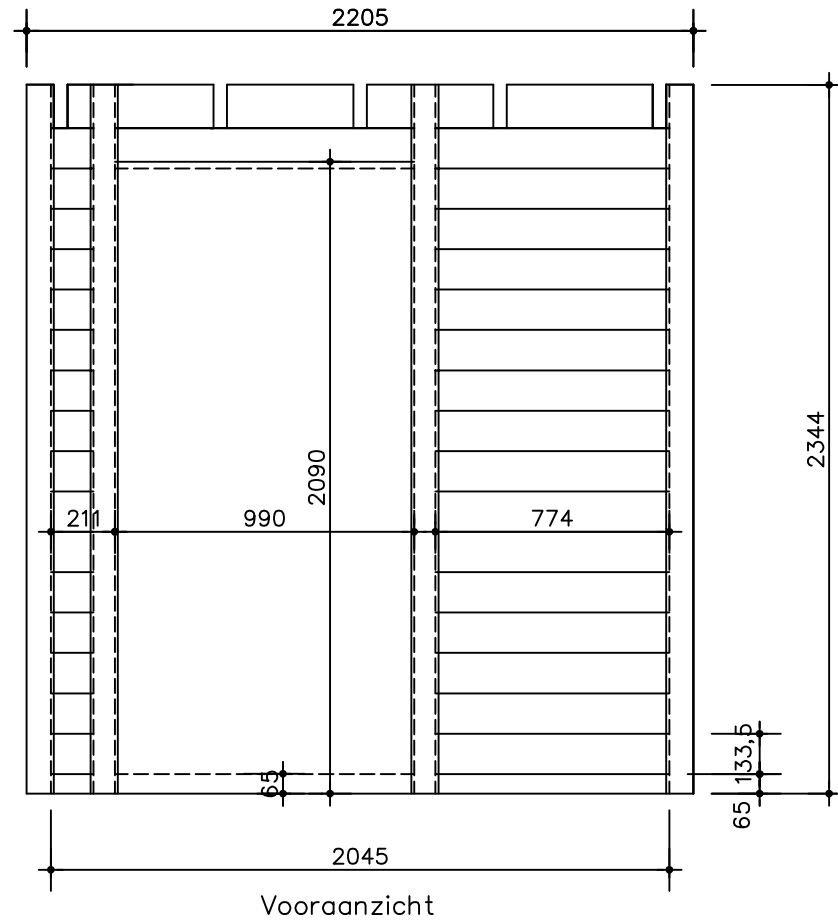

- 1x246 1x156 1x191
- 1x86 1x417 1x483
- 16x211 1x990 16x774
- 1x211 1x990 1x774

Sauna bio1770 (2205x1905)
 schaal 1:25

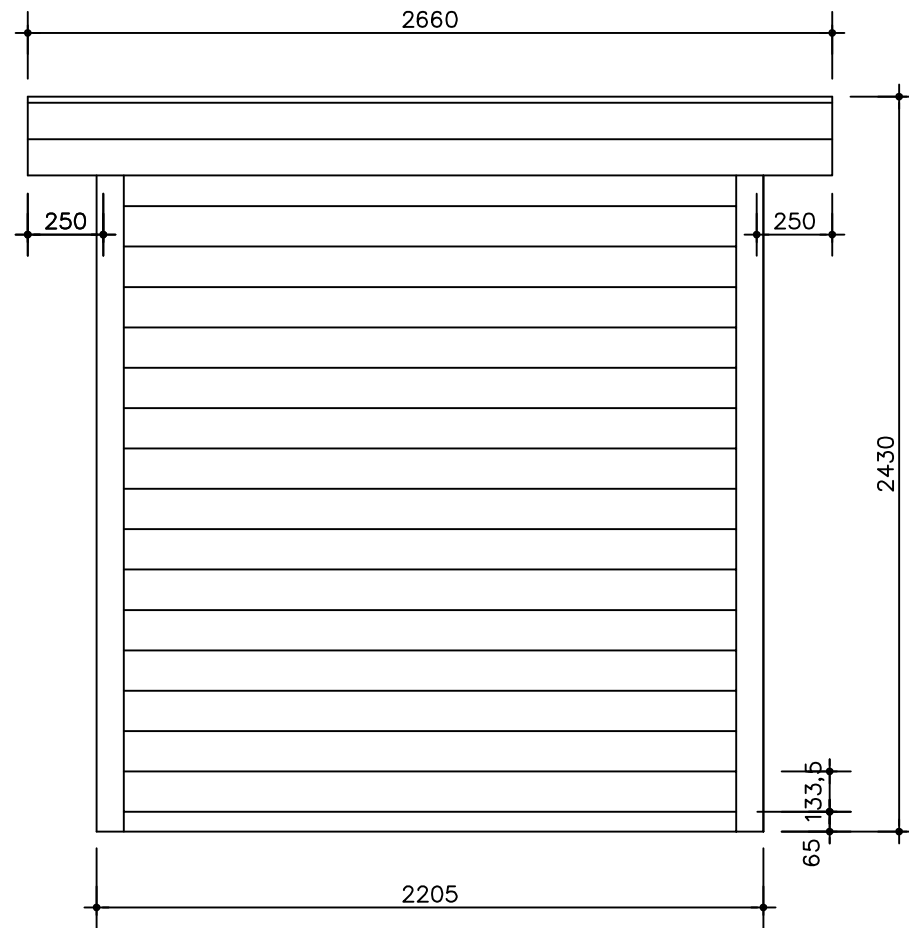

Achteraanzicht

Sauna bio1770 (2205x1905)
schaal 1:25

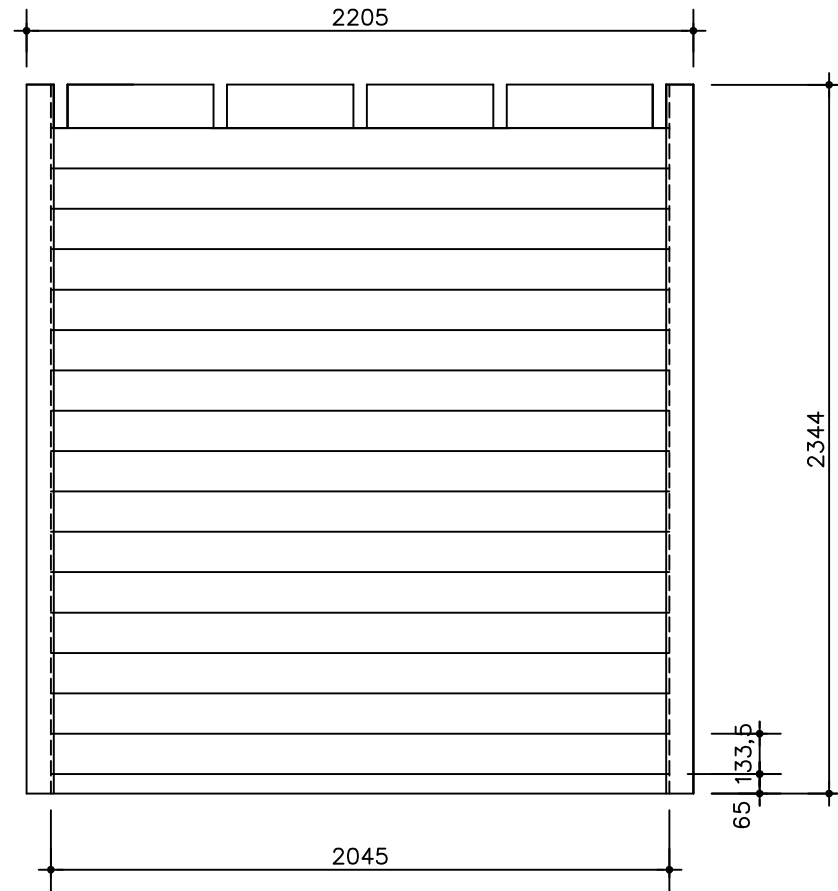

Achteraanzicht

1x483 1x417 1x417 1x483

16x2045

1x2045

Sauna bio1770 (2205x1905)
 schaal 1:25

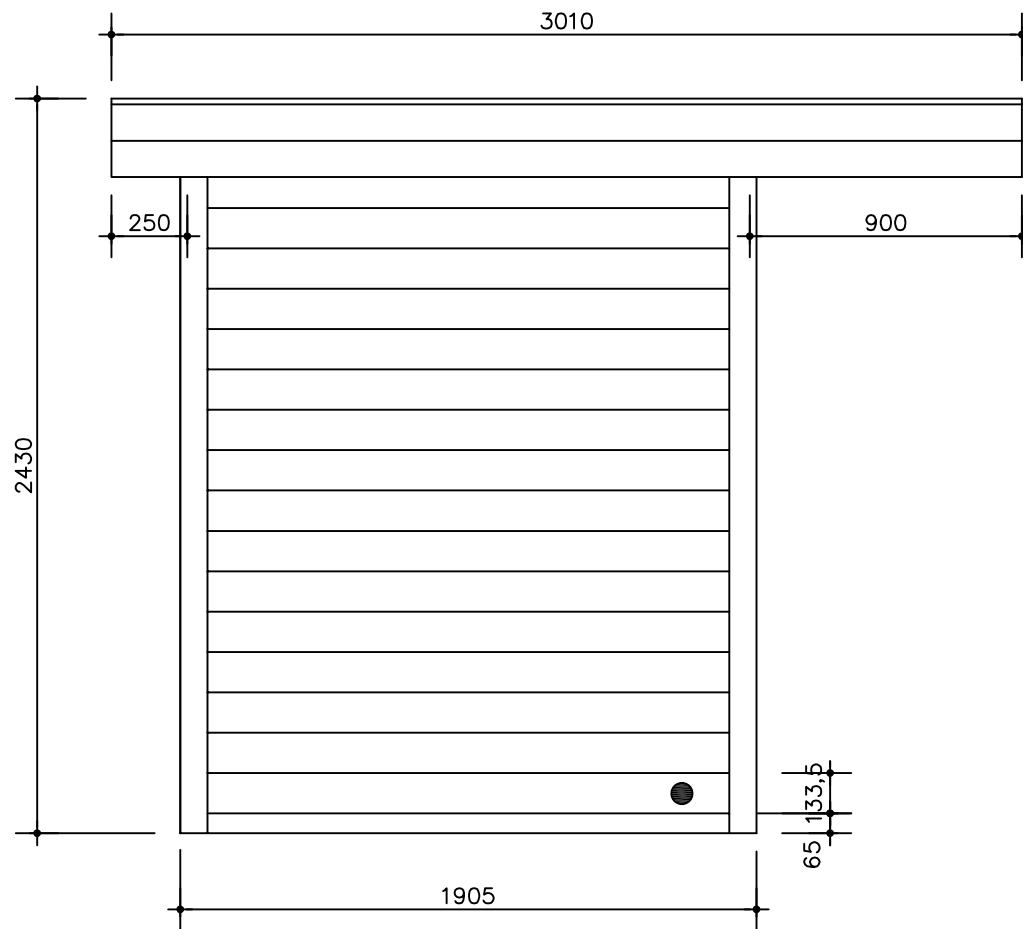

Zijaanzicht links

Sauna bio1770 (2205x1905)
schaal 1:25

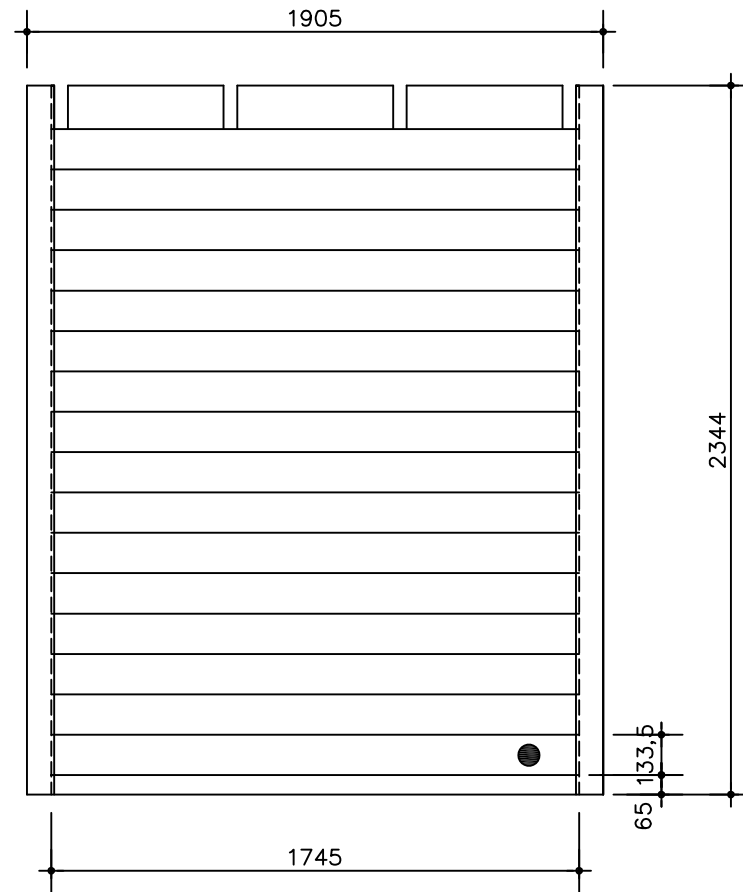

Zijaanzicht links

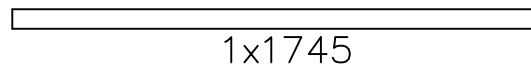
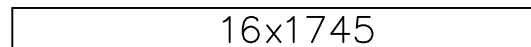
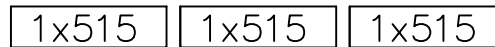

Sauna bio1770 (2205x1905)
 schaal 1:25

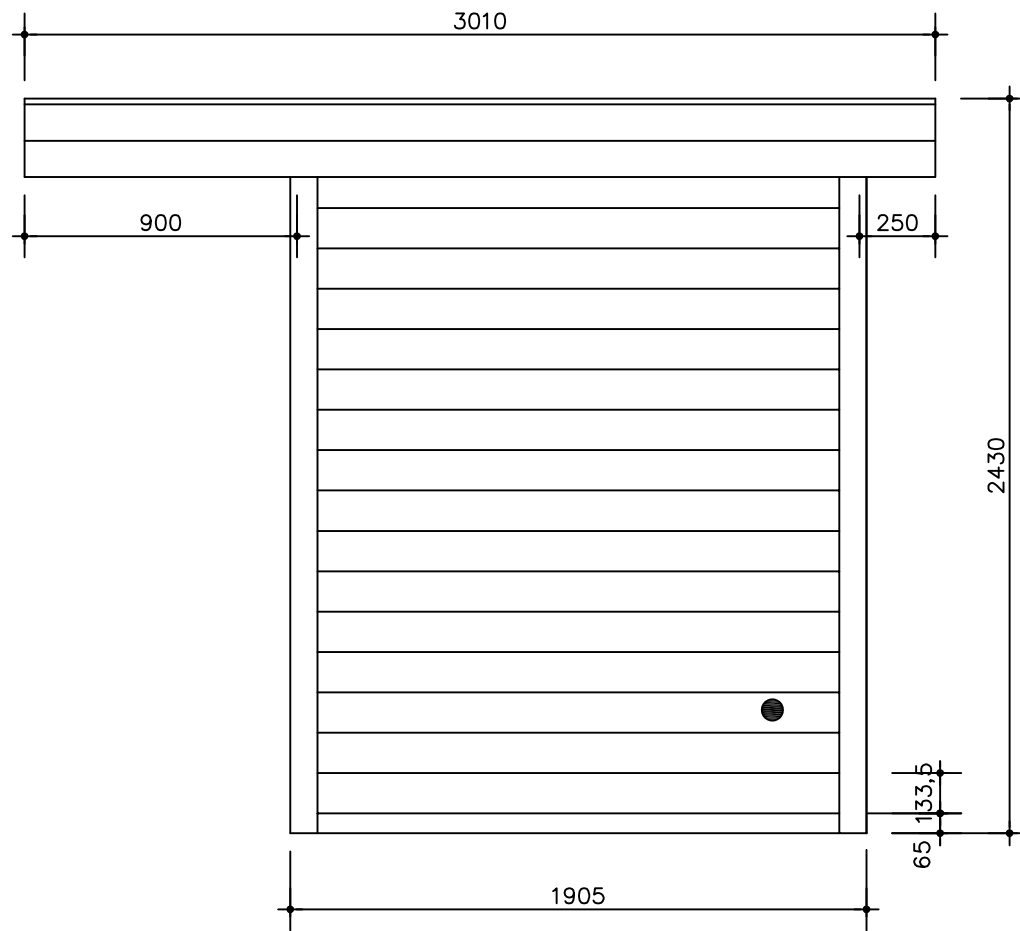

Zijaanzicht rechts

Sauna bio1770 (2205x1905)
schaal 1:25

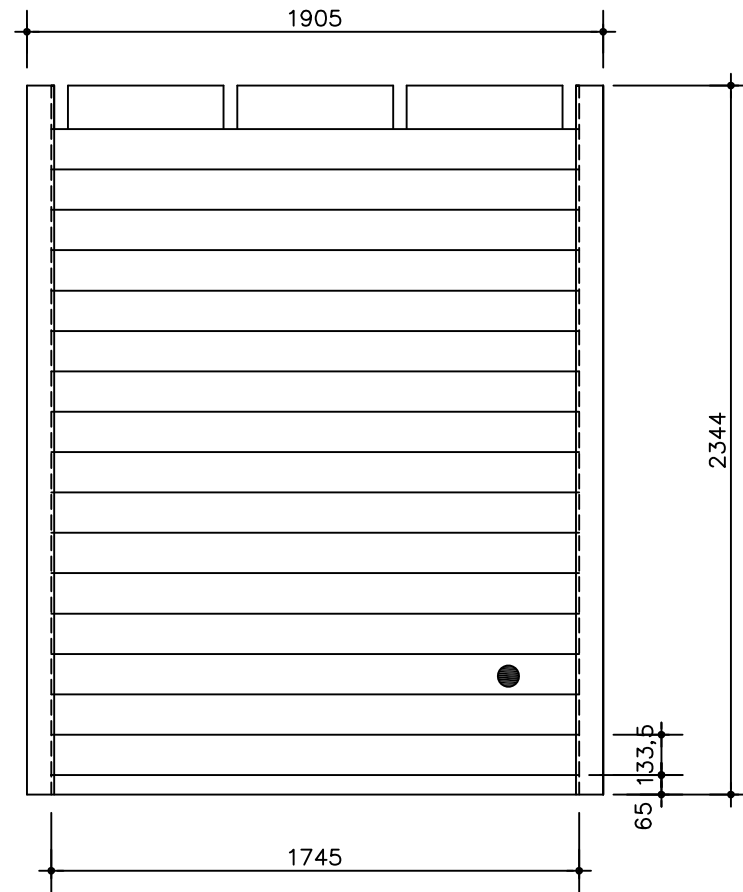

Zijaanzicht rechts

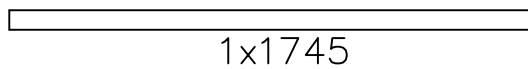
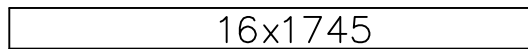
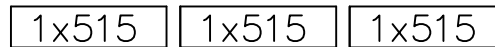

Sauna bio1770 (2205x1905)
 schaal 1:25

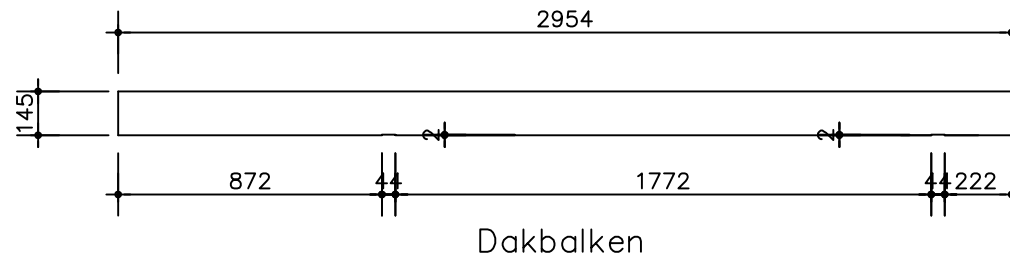

Windveren en dakbalken

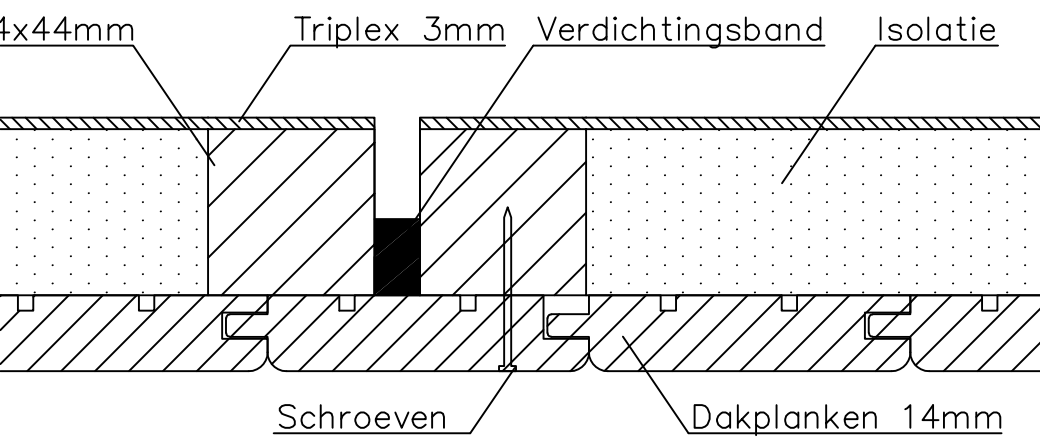
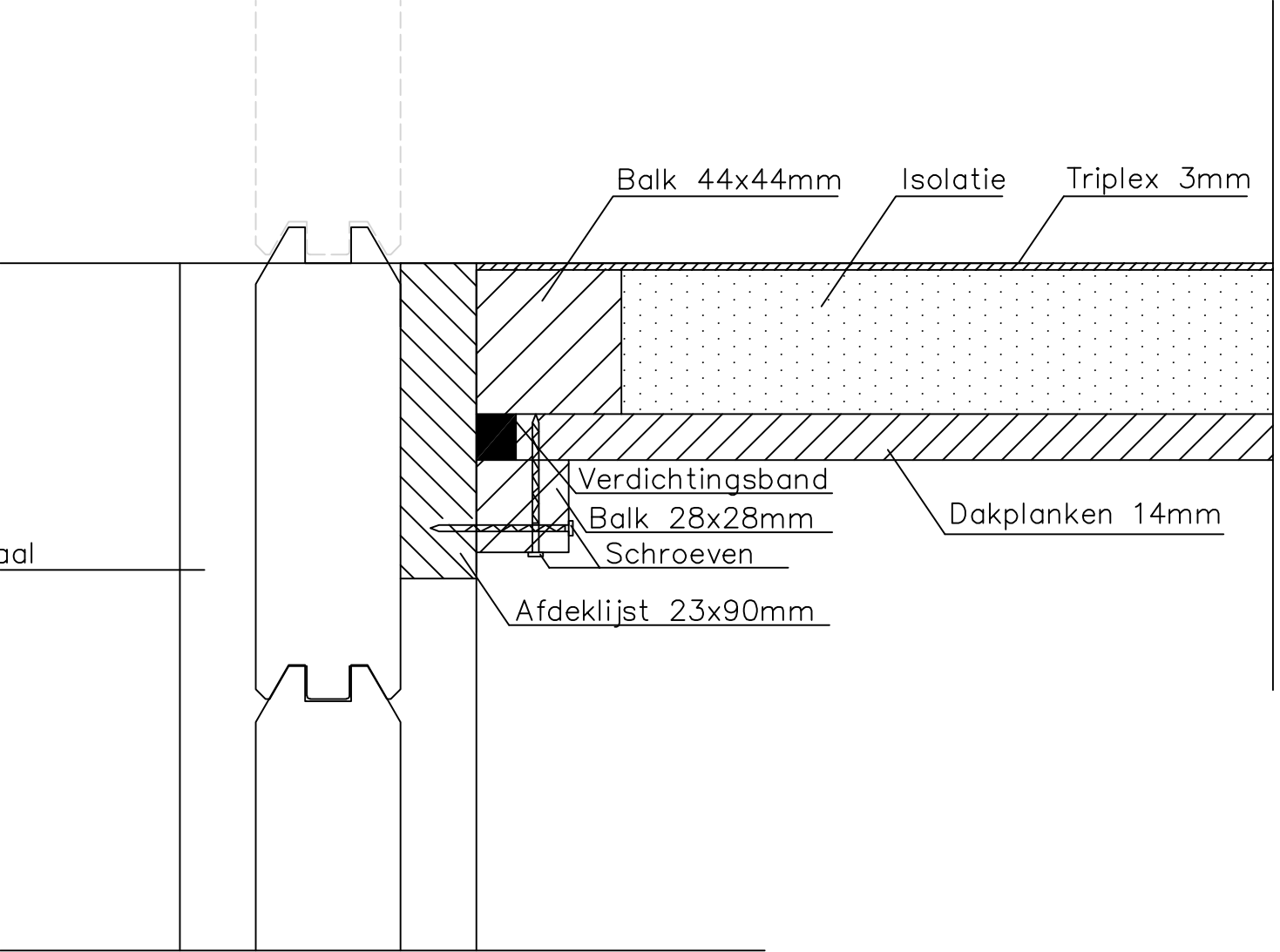

Detail dakconstructie

70 (2205x1905)

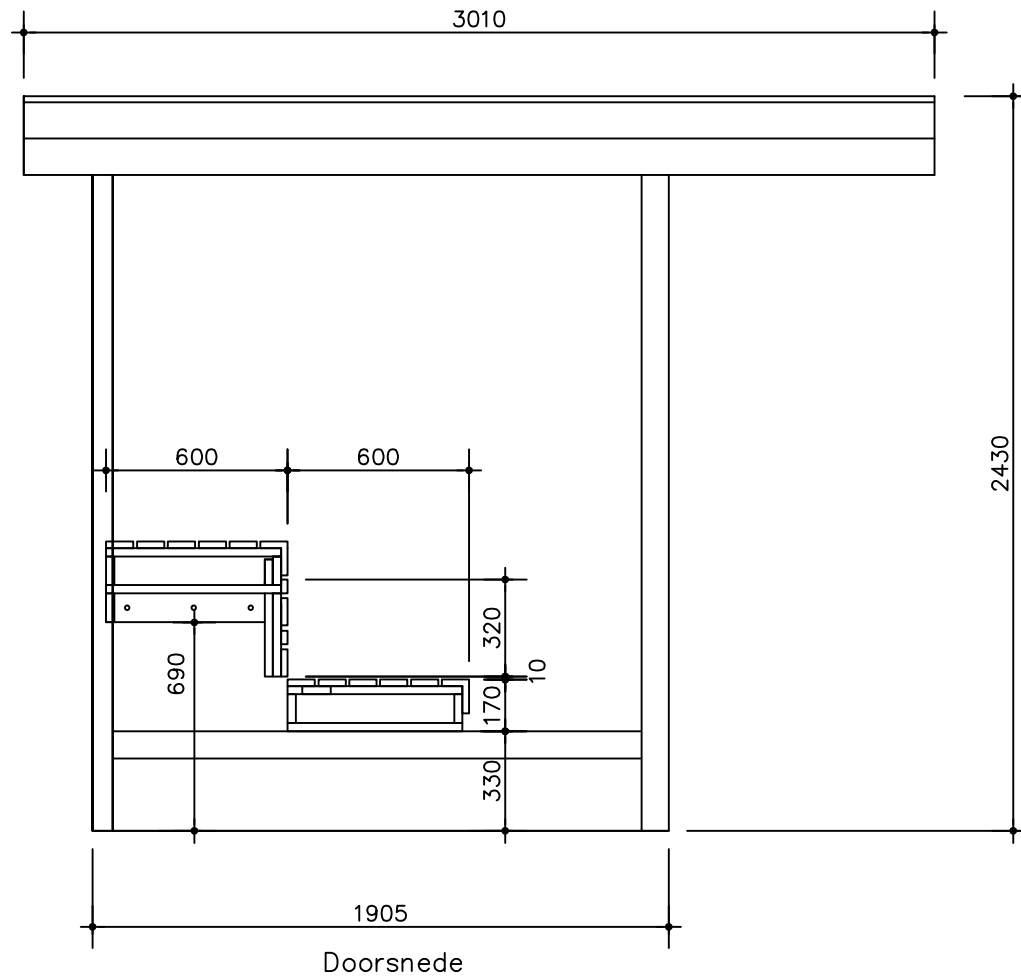

Sauna bio1770 (2205x1905)
schaal 1:25